

LED Exterior Flush Mount

EC16608
INSTALLATION SHEET

START FROM HERE

- Make sure **POWER** is **COMPLETELY OFF** at the fuse box
- Have your fixture installed by a qualified licensed electrician
- Prepare everything in a clear area
- Wear gloves at all time during this installation
- Read instructions carefully before you start assembly
- Keep this installation sheet for future reference

Technical Support: 1-855-855-8926

Please Note:

- This Kuzco LED fixtures come with pre-wired LED module(s)
- Unless instructed, Do Not touch any part of the LED module(s) as any unnecessary contact with the module could cause permanent damage
- Use ELV (Electronic Low Voltage) or TRIAC type of dimmer for dimming application
- Must be installed on a covered ceiling
- 120V input

- 1.** Remove fixture from its original package
- 2.** Separate mounting plate (1c) from canopy (2a) by loosening set screws (2b)
- 3.** Attach mounting plate (1c) to electrical junction box (1a) using screws provided (1e) in hardware package
- 4.** Make proper electrical connections (black to hot "L", white to neutral "N", ground to "GND") with wire nuts (1b) provided in hardware package
- 5.** Align mounting plate (1c) to set screws (2b) on canopy (2a), secure by tighten set screws (2b)
- 6.** To prevent moisture from entering outlet box and causing short, seal around perimeter between fixture and mounting surface with weather resistant caulking (see illustration 1)

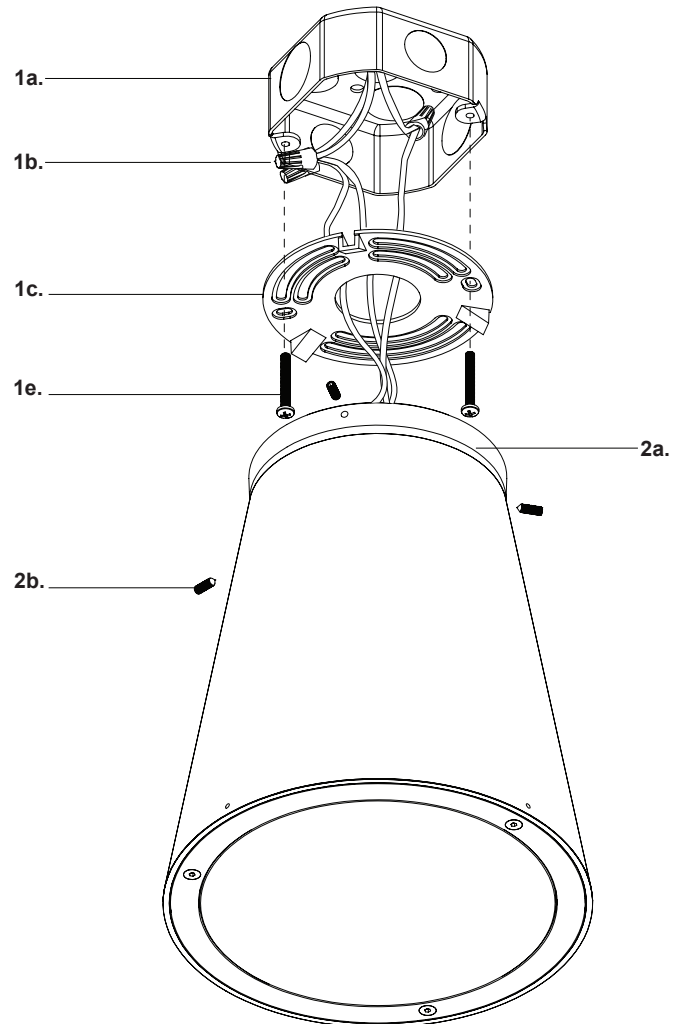
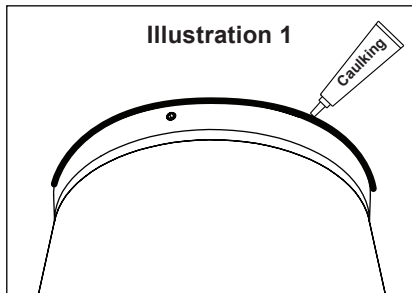

KUZCO

19054 28th Avenue Surrey, BC Canada V3Z 6M3
T: 604 538 7162 TF: 1-855 85 KUZCO F: 604 538 7196
W: kuzcolighting.com
20190614